

GENERAL DESCRIPTION

The 99131 is a driver featuring high speed and wide negative voltage range suited for driving high power MASW series SP2T monolithic switches.

The driver is compatible with 3.3/5.0 V CMOS logic and has a single logic input and 2 outputs to supply each bias line with $-V$ up to $-40V$ and up to ± 40 mA current.

External current limiting resistors are required to set current.

FEATURES

- High speed $<30nS$
- Compatible with CMOS FPGA outputs
- Small 7mm DFN

FUNCTION BLOCK DIAGRAM

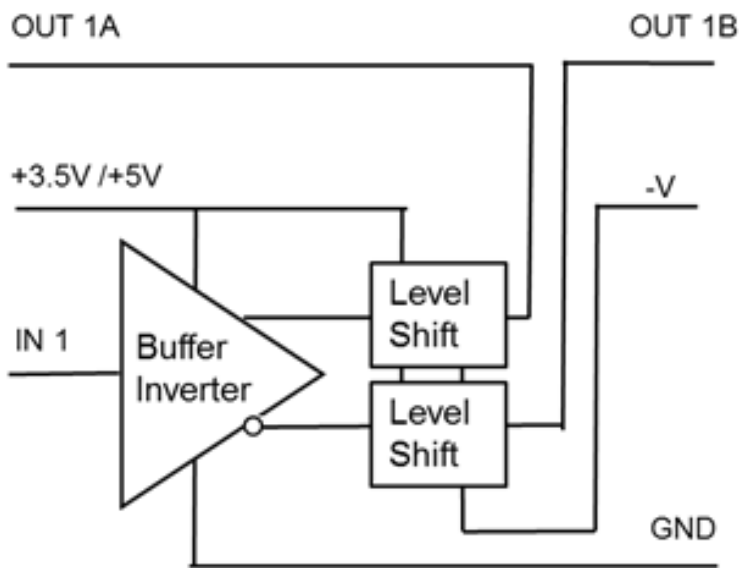

MECHANICAL

The 99131 consists of discrete silicon BJT bonded to a laminate substrate and sealed with a dam and fill process. This forms a 7×7 mm 11 pos 1.27mm pitch SMT assembly designed for integration into an integrated microwave assembly.

99131 is RoHS compliant.

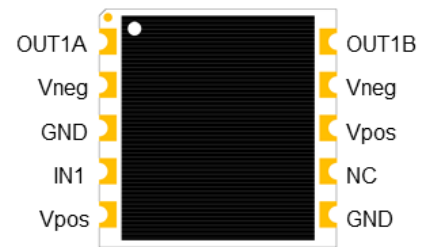

PIN CONNECTIONS

Pins 2, 9, 11 (Vneg) internally connected

Pins 5, 8 (Vpos) internally connected

PIN 11 Backside paddle is Vneg

Recommend bypassing Vpos and Vneg with .47 uF

- 1 Output 1A
- 2 Vneg -5V TO -40V
- 3 Ground
- 4 Input 1
- 5 Vpos 3.3V TO 5V
- 6 Ground
- 7 NC
- 8 Vpos 3.3V TO 5V
- 9 Vneg -5V TO -40V
- 10 Output 1B
- 11 Vneg -5V TO -40V

TRUTH TABLE

IN1 OUT1A OUT1B

1	+V	-V
0	-V	+V

ELECTRICAL SPECIFICATIONS

Vpos +3.3V, Vneg -40V, TEMP 25C, PRR .5MHz

	SYMBOL	PARAMETER	CONDITIONS	MIN	TYP	MAX	UNITS
INPUT							
	VI_hi	Voltage Input High	CMOS	2.4	3.1	3.3	V
	VI_low	Voltage Input Low	CMOS	0	.2	1.2	V
OUTPUT							
	VO_hi	Voltage Out High	open load	2.4	2.6	3.0	V
	VO_low	Voltage Out Low	open load	-39.8	-39.5	-39.2	V
	IO_hi	Current Out High	steady state into 1V diode load		40		mA
	IO_low	Current Out Low	steady state into 1V diode load common arm resistor		-40		mA
	lopk	Current Peak Output	sink		-100		mA
SUPPLY							
	IQC_pos	Quiescent Current Positive	0.5 KHz 50% duty cycle		3		mA
	IQC_neg	Quiescent Current Negative	0.5KHz 50% duty cycle		2		mA
DYNAMIC							
	Trise	Time Rise			10		nS
	Tfall	Time Fall			10		nS
	Td_rise	Delay Rise			7		nS
	Td_fall	Delay Fall			7		nS
	TSW_rise	Switching Speed Rise	10pF load		25		nS
	TSW_fall	Switching Speed Fall	10pF load		25		nS
	PRR	Pulse Repetition Rate	Max, 10pF load		1	2	MHz

MECHANICAL SPECIFICATIONS

DRAWING NOT TO SCALE. DIMENSIONS ARE IN INCHES, UNLESS OTHERWISE NOTED.

Type: Board

Length 7.0 mm; Width 7.0 mm; Height 2.2 mm MAX

MARKING SPECIFICATIONS

Logo: Impellimax

Part Number: 99131

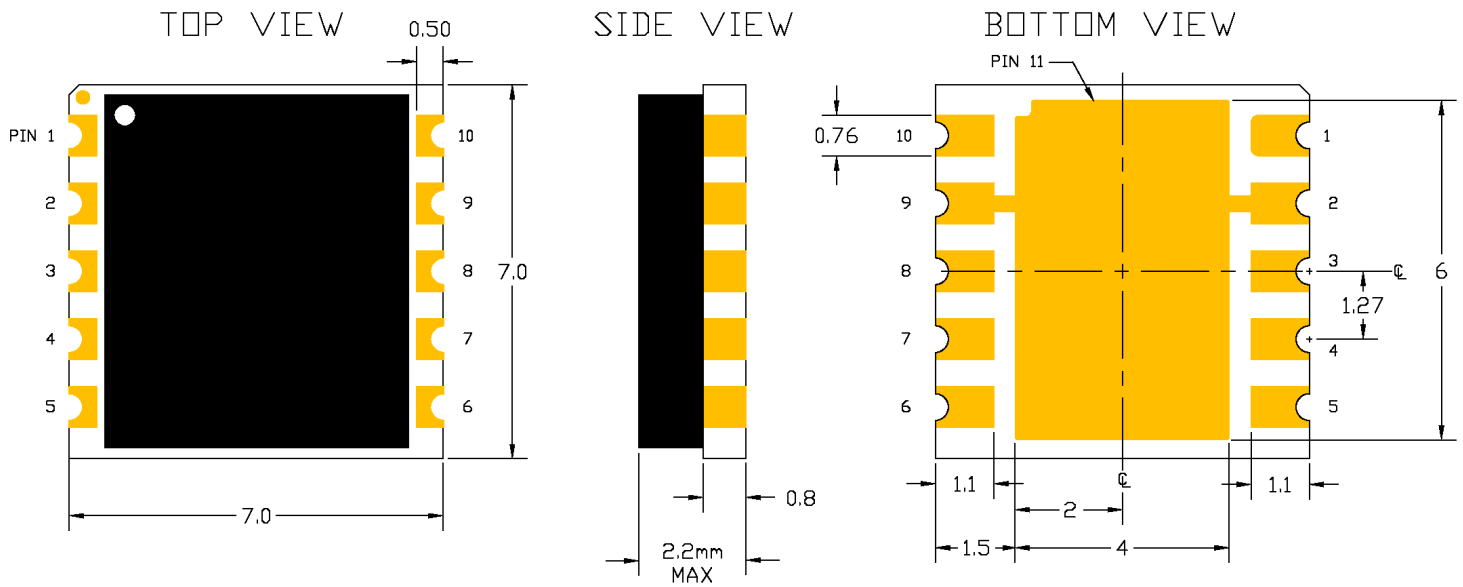

FOOTPRINT

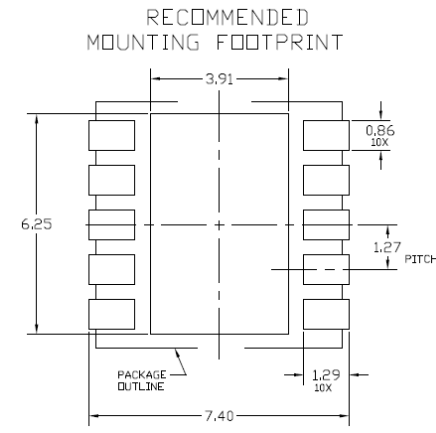

TYPICAL APPLICATION

EXAMPLE 1

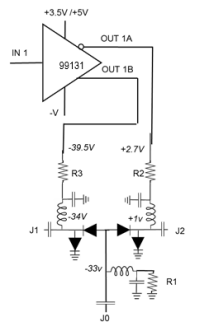

Current Setting Calculator
 Set $R2 = (V_{cc} - 2)/A$. A is desired current in shunt diode
 example $43 \text{ ohm} = (3.3V - 2)/0.03A$

Set $R1 = (V_{ee} + 2)/A$. A is desired current in series diode
 example $1832 \text{ ohm} = (-39.5V + 2)/0.02A$ 43 ohm

This example provides 34 V of back bias to series off diode and 35 V of back bias to shunt off diode

TYPICAL APPLICATION

EXAMPLE 2

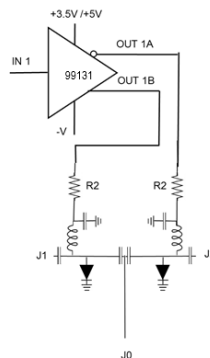

Current Setting Calculator
 Set $R2 = (V_{cc} - 2)/A$. A is desired current in shunt diode
 example $100 \text{ ohm} = (5V - 2)/0.03A$

TYPICAL APPLICATION

EXAMPLE 3

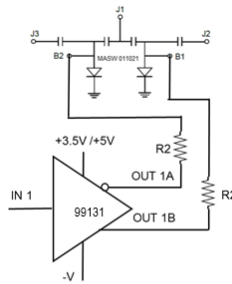

Current Setting Calculator
 Set $R2 = (V_{cc} - 2V) / A$ A is desired current in shunt diode
 example $43 \text{ ohm} = (3.3V - 2V) / 0.03A$